

DIAGNOSTIC TOOLS

2024/2025

PRODUCT LINE
CATALOGUE



strässle&co

Strässle ECG vacuum systems serve as modern interfaces between patients and electrocardiograph. They enable a smooth process of taking ECGs and are indispensable in modern medical practice.

With their differing capabilities, DT100 B, DT100 T and DT80 B, DT80 T as well as the EASY II meet the complete range of requirements made on modern ECG vacuum systems. DT100 B and DT100 T are also available with accumulator batteries.

The range of capabilities of all these systems includes blow feature, 4-level pressure range adjustment with a one-hand operable control unit, LED information, and, of course, defibrillation protection.

The special automatic control circuitry controls vacuum pumps in a modified pivoting technique and provides controlled adhesion even on problem skins, e.g. of very bony or hairy patients.

The electrode lines are equipped with soft and therefore highly adaptive silicone suckers, the interior of which contains a classical silver- silver chloride electrode.

A continuous high-quality shielding protection against oxidation and a controlled manufacturing process enable the transmission of sensitive measurement potentials and thus a sure diagnosis. Strässle ECG vacuum systems are high-quality medical diagnostic tools and an integrated component of medical and economical investment in modern practice and clinics.

Informative: Each Distributor or end user who combines or assembles Products of Strässle & Co. Medizintechnik GmbH with other products into a system is subject to the requirements set out in (EU) MDR 2017/745 article 22!

**Strässle & Co.
Medizintechnik GmbH
Primelweg 5
D-72461 Albstadt**

Tel.: +49 (0)7432 22 01 86

Fax: +49 (0)7432 22 01 89

info@straessle-co.de

www.straessle-co.de

Table of contents

	page
DT80 T table model (with or without table clamp)	4
DT80 T plus	5
DT80 T with carriage I	6
DT80 T with carriage H	7
DT80 B table model (with or without table clamp)	8
DT80 B plus	9
DT80 B with carriage I	10
DT80 B with carriage H	11
DT100 T table model (with table clamp)	12
DT100 T table model (without table clamp)	13
DT100 T plus	14
DT100 T with carriage I	15
DT100 T with carriage H	16
DT100 B table model (with table clamp)	17
DT100 B table model (without table clamp)	18
DT100 B plus	19
DT100 B with carriage I	20
DT100 B with carriage H	21
EASY II	22
DT Basic and DT Basic T	23
Vacuum pump unit DT100/DT80/Easy / remote control for DT100	24
Support arms T/B	25
Carriage I	26
Carriage H	27
Carriage Plus (mobile stand)	27
Mounting kits	
Mounting kit 1/2/3 (angle mountings)	28
Mounting kit 4/5/6 (Haeberle, Munz)	29
Mounting kit 7/8/9 (ITD classic cart, Vacucar)	30
Mounting kit 10/11/12 (Schiller CS200 I, CardioCart mobil, Philips ST80i)	31
Mounting kit 13/14/15 (Schiller CS200 II Facelift, Philips TC cart)	32
Mounting kit 16/17/18 (clamp mountings, GE cart MAC2000)	33
Mounting kit 19/20/21 (Schiller X1/X3, X2, X4)	34
Mounting kit 22 (GE MAC5/MAC7)/Table clamp / accessory set for arm mountings A	35
Wall mountings for support arms and vacuum units	36
Optional accessories	
Electrode distance holder / Suction line holder A	37
Suction line holder B / Suction line holder C / Suction line holder T	38
Weight for patient line cable T / Brackets screwable / Fixing bracket set for metal clip	39
Bottle holder for contact spray / Extension for patient cable / Adapter cable /	40
Medi-Box (adapter box) / Test Box DT	41
Consumption and replacement material	
Quick disinfectant / Electrode spray	42
Suction lines with electrodes / Coding plates / Identifiers	43
Leads for self-adhesive electrodes with snap fastener	44
Terms of business	45

Subject to alterations. Our sales and delivery conditions are valid.

This product line catalogue is valid from 2025, January 01 and replaces all previous product line catalogues.

Strässle & Co. Medizintechnik GmbH Tel.: + 49 (0) 7432 22 01 86 Fax: + 49 (0) 7432 22 01 89 email: info@straessle-co.de

www.straessle-co.de

©Strässle & Co

DT80 T



[Illustration with special equipment, table is not included]

DT80 T

DT80 T table model with clamping screw for clamping on tables etc.

A small vacuum unit with a telescopic support arm, designed for occasional use in medical practice.

Comfortable operation, one-hand control, and a long-reach support arm are the special features of this model.

The system has proven control technology in four pressure levels and, like all vacuum systems by Strässle, an automatic blow feature, before and after every use.

Specifications:

- Protection class I ; MPG Class 1
- Supply voltage 230 V~ 50/60 Hz; 22VA
- Vacuum range 60-200 mbar
- Four-level adjustment of vacuum capacity
Pressure range and status indication
- Support arm with integrated Defibrillation protection; swivel range approx. 360°
- Silver-silver chloride electrodes; Sucker material silicone; individually exchangeable from outside
- Clamping device with fixing range of 20-55mm
(only for 4000-320 and 4000-321)

Item No.	Type	Scope of delivery / Description
4000-320	DT80 T	10x vacuum electrode 1m; 1x support arm T; 1x vacuum unit DT80 with control unit and holder for control unit; 1x support for control unit; 1x clamping device ; 1x power cable; 250ml electrode spray
4000-321	DT80 T	6x vacuum electrode 1m and 4x1.3m ; 1x support arm T; 1x vacuum unit DT80 with control unit and holder for control unit; 1x support for control unit; 1x clamping device ; 1x power cable; 250ml electrode spray
Item No.	Type	Scope of delivery / Description
4000-350	DT80 T	10x vacuum electrode 1m; 1x support arm T; 1x vacuum unit DT80 with control unit and holder for control unit; 1x support for control unit; 1x power cable; 250ml electrode spray; without mounting kit
4000-351	DT80 T	6x vacuum electrode 1m and 4x1.3m ; 1x support arm T; 1x vacuum unit DT80 with control unit and holder for control unit; 1x support for control unit; 1x power cable; 250ml electrode spray; without mounting kit

Subject to alterations. Our sales and delivery conditions are valid.

This product line catalogue is valid from 2025, January 01 and replaces all previous product line catalogues.

Strässle & Co. Medizintechnik GmbH Tel.: + 49 (0) 7432 22 01 86 Fax: + 49 (0) 7432 22 01 89 email: info@straessle-co.de
www.straessle-co.de ©Strässle & Co

DT80 Tplus



DT80 Tplus

The DT80 T is also available in the Plus-version DT80 Tplus.

The housing with the vacuum pump is fixed between the housing base and the base plate by a resistant tape. Functional connections such as vacuum connection and control unit are located at the rear of the housing.

The base plate is very solid.

Width 38cm, Depth 40cm
Four lockable caster wheels

Item No.	Type	Scope of delivery / Description
4000-322	DT80 Tplus	10x vacuum electrode 1m; 1x support arm T; 1x vacuum unit DT80 with control unit and holder for control unit; 1x carriage plus; 1x power cable; 250ml electrode spray
4000-323	DT80 Tplus	6x vacuum electrode 1m and 4x1.3m; 1x support arm T; 1x vacuum unit DT80 with control unit and holder for control unit; 1x carriage plus; 1x power cable; 250ml electrode spray

Subject to alterations. Our sales and delivery conditions are valid.

This product line catalogue is valid from 2025, January 01 and replaces all previous product line catalogues.

Strässle & Co. Medizintechnik GmbH Tel.: + 49 (0) 7432 22 01 86 Fax: + 49 (0) 7432 22 01 89 email: info@straessle-co.de

www.straessle-co.de

©Strässle & Co

DT80 T with carriage I



[shown carriage with optional equipment]

DT80 TI with carriage

Combination of ECG vacuum unit DT80 and carriage I

Telescopic support arm, small vacuum unit, one-hand control with four pressure levels and blow feature

A solid carriage with **3 large shelves**

Four wheels Ø 10cm, two of them lockable

Carriage extendable

Item No.	Type	Scope of delivery / Description
4000-324	DT80 TI	10x vacuum electrode 1m; 1x support arm T; 1x vacuum unit DT80 with control unit and holder for control unit; 1x carriage I; 1x power cable; 250ml electrode spray
4000-325	DT80 TI	6x vacuum electrode 1m and 4x1,3m ; 1x support arm T; 1x vacuum unit DT80 with control unit and holder for control unit; 1x carriage I; 1x power cable; 250ml electrode spray

DT80 T with carriage H



DT80 TH with carriage

A combination of ECG vacuum unit DT80 T and carriage H.

Manoeuvrable carriage with small vacuum unit and telescopic support arm.

[similar to figure]

Item No.	Type	Scope of delivery / Description
4000-326	DT80 TH	10x vacuum electrode 1m; 1x support arm T; 1x vacuum unit DT80 with control unit and holder for control unit; 1x carriage H; 1x power cable; 250ml electrode spray
4000-327	DT80 TH	6x vacuum electrode 1m and 4x1,3m; 1x support arm T; 1x vacuum unit DT80 with control unit and holder for control unit; 1x carriage H; 1x power cable; 250ml electrode spray

Subject to alterations. Our sales and delivery conditions are valid.

This product line catalogue is valid from 2025, January 01 and replaces all previous product line catalogues.

Strässle & Co. Medizintechnik GmbH Tel.: + 49 (0) 7432 22 01 86 Fax: + 49 (0) 7432 22 01 89 email: info@straessle-co.de

www.straessle-co.de

©Strässle & Co

DT80 B



[Illustration with special equipment, table is not included]

DT80 B

DT80 B in table model version

A small vacuum unit with a large support arm, designed for occasional use in medical practice.

Comfortable operation, one-hand control, and a long-reach support arm are the special features of this model.

The system has proven control technology in four pressure levels and, like all vacuum systems by Strässle, an automatic blow feature, before and after every use.

Specifications:

- Protection class I ; MPG Class 1
- Supply voltage 230 V~ 50/60 Hz; 22VA
- Vacuum range 60-200 mbar
- Four-level adjustment of vacuum capacity
Pressure range and status indication
- Support arm with integrated Defibrillation protection; swivel range approx. 315°
- Silver- silver chloride electrodes; Sucker material silicone; individually exchangeable from outside
- Clamping device with fixing range of 20-55mm
(only for 4000-500 and 4000-501)

Item No.	Type	Scope of delivery / Description
4000-500	DT80 B	10x vacuum electrode 1m; 1x support arm B; 1x vacuum unit DT80 with control unit and holder for control unit; 1x clamping device ; 1x power cable; 250ml electrode spray
4000-501	DT80 B	6x vacuum electrode 1m and 4x1.3m ; 1x support arm B; 1x vacuum unit DT80 with control unit and holder for control unit; 1x clamping device ; 1x power cable; 250ml electrode spray
Item No.	Type	Scope of delivery / Description
4000-510	DT80 B	10x vacuum electrode 1m; 1x support arm B; 1x vacuum unit DT80 with control unit and holder for control unit; 1x power cable; 250ml electrode spray; without mounting kit
4000-511	DT80 B	6x vacuum electrode 1m and 4x1.3m ; 1x support arm B; 1x vacuum unit DT80 with control unit and holder for control unit; 1x power cable; 250ml electrode spray; without mounting kit

Subject to alterations. Our sales and delivery conditions are valid.

This product line catalogue is valid from 2025, January 01 and replaces all previous product line catalogues.

Strässle & Co. Medizintechnik GmbH Tel.: + 49 (0) 7432 22 01 86 Fax: + 49 (0) 7432 22 01 89 email: info@straessle-co.de
www.straessle-co.de ©Strässle & Co

DT80 Bplus



DT80 Bplus

The DT80 B is also available in the Plus-version.

The housing with the vacuum pump is fixed between the housing base and the base plate by a resistant tape. Functional connections such as vacuum connection and control unit are located at the rear of the housing.

The base plate is very solid.

Width 38cm, Depth 40cm
Four lockable caster wheels

[Illustration with special equipment]

Item No.	Type	Scope of delivery / Description
4000-502	DT80 Bplus	10x vacuum electrode 1m; 1x support arm B; 1x vacuum unit DT80 with control unit and holder for control unit; 1x carriage plus; 1x power cable; 250ml electrode spray
4000-503	DT80 Bplus	6x vacuum electrode 1m and 4x1,3m; 1x support arm B; 1x vacuum unit DT80 with control unit and holder for control unit; 1x carriage plus; 1x power cable; 250ml electrode spray

Subject to alterations. Our sales and delivery conditions are valid.

This product line catalogue is valid from 2025, January 01 and replaces all previous product line catalogues.

Strässle & Co. Medizintechnik GmbH Tel.: + 49 (0) 7432 22 01 86 Fax: + 49 (0) 7432 22 01 89 email: info@straessle-co.de

www.straessle-co.de

©Strässle & Co

DT80 B with carriage I



DT80 BI with carriage

Combination of ECG vacuum unit DT80 B and carriage I

Large support arm, small vacuum unit, one-hand control with four pressure levels and blow feature

A solid carriage with **3 large shelves**

Four wheels Ø 10cm, two of them lockable

Carriage extendable

[shown carriage with optional equipment]

Item No.	Type	Scope of delivery / Description
4000-504	DT80 BI	10x vacuum electrode 1m; 1x support arm B; 1x vacuum unit DT80 with control unit and holder for control unit; 1x carriage I; 1x power cable; 250ml electrode spray
4000-505	DT80 BI	6x vacuum electrode 1m and 4x1.3m; 1x support arm B; 1x vacuum unit DT80 with control unit and holder for control unit; 1x carriage I; 1x power cable; 250ml electrode spray

DT80 B with carriage H



DT80 BH with carriage

A combination of ECG vacuum unit DT80 B and carriage H

Manoeuvrable carriage with small vacuum unit and long support arm

*[similar to figure,
With optional equipment]*

Item No.	Type	Scope of delivery / Description
4000-506	DT80 BH	10x vacuum electrode 1m; 1x support arm B; 1x vacuum unit DT80 with control unit and holder for control unit; 1x carriage H; 1x power cable; 250ml electrode spray
4000-507	DT80 BH	6x vacuum electrode 1m and 4x1.3m; 1x support arm B; 1x vacuum unit DT80 with control unit and holder for control unit; 1x carriage H; 1x power cable; 250ml electrode spray

Subject to alterations. Our sales and delivery conditions are valid.

This product line catalogue is valid from 2025, January 01 and replaces all previous product line catalogues.
 Strässle & Co. Medizintechnik GmbH Tel.: + 49 (0) 7432 22 01 86 Fax: + 49 (0) 7432 22 01 89 email: info@straessle-co.de
 www.straessle-co.de

©Strässle & Co

DT100 T



[Illustration with special equipment, table is not included]

DT100 T ECG – vacuum system with table clamp

Solid table model with clamping screw for clamping on tables etc.

The device has a telescopic, flexible support arm, a high-volume vacuum pump with blow feature and controlled vacuum technology.

Specifications

- Protection class I; MPG Class 1
- Supply voltage 115/230 V~ 50/60 Hz; 50 VA
- Vacuum range 60–260 mbar; four-level vacuum capacity adjustment; Pressure range and status indication
- Support arm with integrated defibrillation protection; pivoting range approx. 360°
- Silver- silver chloride electrodes; sucker material silicone; individually exchangeable from the outside
- Optionally with accumulator battery
- Accumulator capacity sufficient for 6 h
- **Clamping screw with fixing range 20 – 55 mm**

Item No.	Type	Scope of delivery / Description
4000-264	DT100 T	10x vacuum electrode 1m; 1x support arm T; 1x vacuum unit DT100; 1x control unit with holder; 1x clamping device ; 1x power cable; 250ml electrode spray
4000-262	DT100 T	6x vacuum electrode 1m and 4x1,3m ; 1x support arm T; 1x vacuum unit DT100; 1x control unit with holder; 1x clamping device ; 1x power cable; 250ml electrode spray

Systems with accumulator battery:

4000-265	DT100A T	10x vacuum electrode 1m; 1x support arm T; 1x vacuum unit DT100 with integrated accumulator battery ; 1x control unit with holder; 1x clamping device ; 1x power cable; 250ml electrode spray
4000-263	DT100A T	6x vacuum electrode 1m and 4x1,3m ; 1x support arm T; 1x vacuum unit DT100 with integrated accumulator battery ; 1x control unit with holder; 1x clamping device ; 1x power cable; 250ml electrode spray

Subject to alterations. Our sales and delivery conditions are valid.

This product line catalogue is valid from 2025, January 01 and replaces all previous product line catalogues.

Strässle & Co. Medizintechnik GmbH Tel.: + 49 (0) 7432 22 01 86 Fax: + 49 (0) 7432 22 01 89 email: info@straessle-co.de
www.straessle-co.de ©Strässle & Co

DT100 T



[Illustration with special equipment, table and table clamp are not included]

DT100 T ECG – vacuum system without table clamp

The device has a telescopic, flexible support arm, a high-volume vacuum pump with blow feature and controlled vacuum technology.

Specifications

- Protection class I; MPG Class 1
- Supply voltage 115/230 V~ 50/60 Hz; 50 VA
- Vacuum range 60–260 mbar; four-level vacuum capacity adjustment; Pressure range and status indication
- Support arm with integrated defibrillation protection; pivoting range approx. 360°
- Silver- silver chloride electrodes; sucker material silicone; individually exchangeable from the outside
- Optionally with accumulator battery
- Accumulator capacity sufficient for 6 h
- **Without mounting kit**

Item No.	Type	Scope of delivery / Description
4000-358	DT100 T	10x vacuum electrode 1m; 1x support arm T; 1x vacuum unit DT100; 1x control unit with holder; 1x power cable; 250ml electrode spray; without mounting kit
4000-359	DT100 T	6x vacuum electrode 1m and 4x1,3m ; 1x support arm T; 1x vacuum unit DT100; 1x control unit with holder; 1x power cable; 250ml electrode spray; without mounting kit

Systems with accumulator battery:

4000-360	DT100A T	10x vacuum electrode 1m; 1x support arm T; 1x vacuum unit DT100 with integrated accumulator battery ; 1x control unit with holder; 1x power cable; 250ml electrode spray; without mounting kit
4000-361	DT100A T	6x vacuum electrode 1m and 4x1,3m ; 1x support arm T; 1x vacuum unit DT100 with integrated accumulator battery ; 1x control unit with holder; 1x power cable; 250ml electrode spray; without mounting kit

Subject to alterations. Our sales and delivery conditions are valid.

This product line catalogue is valid from 2025, January 01 and replaces all previous product line catalogues.
 Strässle & Co. Medizintechnik GmbH Tel.: + 49 (0) 7432 22 01 86 Fax: + 49 (0) 7432 22 01 89 email: info@straessle-co.de
 www.straessle-co.de

DT100 Tplus



DT100 Tplus

The telescopic support arm T for mobile practical use.

Stand-alone version, carriage with integrated vacuum unit DT100

Mobile operation

Base plate

Very solid design

Width 38 cm

Depth 40 cm

Four lockable caster wheels

Item No.	Type	Scope of delivery / Description
4000-275	DT100 Tplus	10x vacuum electrode 1m; 1x support arm T; 1x vacuum unit DT100; 1x control unit with holder; 1x carriage plus; 1x power cable; 250ml electrode spray
4000-273	DT100 Tplus	6x vacuum electrode 1m and 4x1,3m; 1x support arm T; 1x vacuum unit DT100; 1x control unit with holder; 1x carriage plus; 1x power cable; 250ml electrode spray

Systems with accumulator battery:

4000-276	DT100A Tplus	10x vacuum electrode 1m; 1x support arm T; 1x vacuum unit DT100 with integrated accumulator battery; 1x control unit with holder; 1x carriage plus; 1x power cable; 250ml electrode spray
4000-274	DT100A Tplus	6x vacuum electrode 1m and 4x1,3m; 1x support arm T; 1x vacuum unit DT100 with integrated accumulator battery; 1x control unit with holder; 1x carriage plus; 1x power cable; 250ml electrode spray

DT100 T with carriage I



[shown carriage with optional equipment]

DT100 TI with carriage

The telescopic support arm version T with vacuum unit DT100 on carriage I.

The large shelf with a running edge provides a secure position for electro medical devices. Rounded edges avoid injuries.

The surfaces are easy to clean and resistant against disinfectants and detergents.

The push-and lift handle facilitates moving and lifting the carriage.

Large twin caster wheels \varnothing 100mm provide comfortable motion.

Front wheels lockable
Three shelves

Item No.	Type	Scope of delivery / Description
4000-269	DT100 TI	10x vacuum electrode 1m; 1x support arm T; 1x vacuum unit DT100; 1x control unit with holder; 1x carriage I; 1x power cable; 250ml electrode spray
4000-271	DT100 TI	6x vacuum electrode 1m and 4x1,3m ; 1x support arm T; 1x vacuum unit DT100; 1x control unit with holder; 1x carriage I; 1x power cable; 250ml electrode spray

Systems with accumulator battery:

4000-270	DT100A TI	10x vacuum electrode 1m; 1x support arm T; 1x vacuum unit DT100 with integrated accumulator battery ; 1x control unit with holder; 1x carriage I; 1x power cable; 250ml electrode spray
4000-272	DT100A TI	6x vacuum electrode 1m and 4x1,3m ; 1x support arm T; 1x vacuum unit DT100 with integrated accumulator battery ; 1x control unit with holder; 1x carriage I; 1x power cable; 250ml electrode spray

Subject to alterations. Our sales and delivery conditions are valid.

This product line catalogue is valid from 2025, January 01 and replaces all previous product line catalogues.

Strässle & Co. Medizintechnik GmbH Tel.: + 49 (0) 7432 22 01 86 Fax: + 49 (0) 7432 22 01 89 email: info@straessle-co.de

www.straessle-co.de

DT100 T with carriage H



[similar to figure]

DT100 TH with carriage

DT100 with telescopic support arm version T on carriage H.

This combination is also suitable for use in hospitals.

Easily manoeuvrable and solid carriage for ECG device and vacuum unit.

Front wheels lockable.

4-fold socket board with circuit breaker.

Item No.	Type	Scope of delivery / Description
4000-283	DT100 TH	10x vacuum electrode 1m; 1x support arm T; 1x vacuum unit DT100; 1x control unit with holder; 1x carriage H; 1x power cable; 250ml electrode spray
4000-285	DT100 TH	6x vacuum electrode 1m and 4x1.3m; 1x support arm T; 1x vacuum unit DT100; 1x control unit with holder; 1x carriage H; 1x power cable; 250ml electrode spray

Systems with accumulator battery:

4000-284	DT100A TH	10x vacuum electrode 1m; 1x support arm T; 1x vacuum unit DT100 with integrated accumulator battery ; 1x control unit with holder; 1x carriage H; 1x power cable; 250ml electrode spray
4000-286	DT100A TH	6x vacuum electrode 1m and 4x1.3m; 1x support arm T; 1x vacuum unit DT100 with integrated accumulator battery ; 1x control unit with holder; 1x carriage H; 1x power cable; 250ml electrode spray

DT100 B



[Illustration with special equipment, table is not included]

DT100 B ECG – vacuum system with table clamp

Solid table model with clamping screw for clamping on tables etc.

The device has a long-reach, flexible support arm, a high-volume vacuum pump with blow feature and controlled vacuum technology.

Battery version available

Specifications:

- Protection class I; MPG Class 1
- Supply voltage 115/230 V~ 50/60 Hz; 50 VA
- Vacuum range 60–260 mbar; four-level vacuum capacity adjustment; Pressure range and status indication
- Support arm with integrated defibrillation protection; pivoting range approx. 315°
- Silver-silver chloride electrodes; sucker material silicone; individually exchangeable from the outside
Optionally with accumulator battery
- Accumulator capacity sufficient for 6 h
- **Clamping screw with fixing range 20 – 55 mm**

Item No.	Type	Scope of delivery / Description
4000-464	DT100 B	10x vacuum electrode 1m; 1x support arm B; 1x vacuum unit DT100; 1x control unit with holder; 1x clamping device ; 1x power cable; 250ml electrode spray
4000-462	DT100 B	6x vacuum electrode 1m and 4x1,3m ; 1x support arm B; 1x vacuum unit DT100; 1x control unit with holder; 1x clamping device ; 1x power cable; 250ml electrode spray

Systems with accumulator battery:

4000-465	DT100A B	10x vacuum electrode 1m; 1x support arm B; 1x vacuum unit DT100 with integrated accumulator battery ; 1x control unit with holder; 1x clamping device ; 1x power cable; 250ml electrode spray
4000-463	DT100A B	6x vacuum electrode 1m and 4x1,3m ; 1x support arm B; 1x vacuum unit DT100 with integrated accumulator battery ; 1x control unit with holder; 1x clamping device ; 1x power cable; 250ml electrode spray

Subject to alterations. Our sales and delivery conditions are valid.

This product line catalogue is valid from 2025, January 01 and replaces all previous product line catalogues.
Strässle & Co. Medizintechnik GmbH Tel.: +49 (0) 7432 22 01 86 Fax: +49 (0) 7432 22 01 89 email: info@straessle-co.de
www.straessle-co.de

©Strässle & Co



[Illustration with special equipment, table and table clamp are not included]

DT100 B ECG – vacuum system without table clamp

The device has a long-reach, flexible support arm, a high-volume vacuum pump with blow feature and controlled vacuum technology.

Battery version available

Specifications:

- Protection class I; MPG Class 1
- Supply voltage 115/230 V~ 50/60 Hz; 50 VA
- Vacuum range 60–260 mbar; four-level vacuum capacity adjustment; Pressure range and status indication
- Support arm with integrated defibrillation protection; pivoting range approx. 315°
- Silver-silver chloride electrodes; sucker material silicone; individually exchangeable from the outside
- Optionally with accumulator battery
- Accumulator capacity sufficient for 6 h
- **Without mounting kit**

Item No.	Type	Scope of delivery / Description
4000-479	DT100 B	10x vacuum electrode 1m; 1x support arm B; 1x vacuum unit DT100; 1x control unit with holder; 1x power cable; 250ml electrode spray; without mounting kit
4000-477	DT100 B	6x vacuum electrode 1m and 4x1,3m ; 1x support arm B; 1x vacuum unit DT100; 1x control unit with holder; 1x power cable; 250ml electrode spray; without mounting kit

Systems with accumulator battery:

4000-480	DT100A B	10x vacuum electrode 1m; 1x support arm B; 1x vacuum unit DT100 with integrated accumulator battery ; 1x control unit with holder; 1x power cable; 250ml electrode spray; without mounting kit
4000-478	DT100A B	6x vacuum electrode 1m and 4x1,3m ; 1x support arm B; 1x vacuum unit DT100 with integrated accumulator battery ; 1x control unit with holder; 1x power cable; 250ml electrode spray; without mounting kit

Subject to alterations. Our sales and delivery conditions are valid.

This product line catalogue is valid from 2025, January 01 and replaces all previous product line catalogues.

DT100 Bplus



DT100 Bplus

The mobile solution for practical use.

Stand-alone version, carriage with integrated vacuum unit DT100

Mobile operation

- Base plate
- Very solid design
- Width 38 cm
- Depth 40 cm
- Four lockable caster wheels

[with optional equipment]

Item No.	Type	Scope of delivery / Description
4000-475	DT100 Bplus	10x vacuum electrode 1m; 1x support arm B; 1x vacuum unit DT100; 1x control unit with holder; 1x carriage plus; 1x power cable; 250ml electrode spray
4000-473	DT100 Bplus	6x vacuum electrode 1m and 4x1,3m; 1x support arm B; 1x vacuum unit DT100; 1x control unit with holder; 1x carriage plus; 1x power cable; 250ml electrode spray

Systems with accumulator battery:

4000-476	DT100A Bplus	10x vacuum electrode 1m; 1x support arm B; 1x vacuum unit DT100 with integrated accumulator battery ; 1x control unit with holder; 1x carriage plus; 1x power cable; 250ml electrode spray
4000-474	DT100A Bplus	6x vacuum electrode 1m and 4x1,3m; 1x support arm B; 1x vacuum unit DT100 with integrated accumulator battery ; 1x control unit with holder; 1x carriage plus; 1x power cable; 250ml electrode spray

Subject to alterations. Our sales and delivery conditions are valid.

This product line catalogue is valid from 2025, January 01 and replaces all previous product line catalogues.

Strässle & Co. Medizintechnik GmbH Tel.: + 49 (0) 7432 22 01 86 Fax: + 49 (0) 7432 22 01 89 email: info@straessle-co.de

www.straessle-co.de

©Strässle & Co

DT100 B with carriage I



DT100 BI with carriage

The large shelf with a running edge provides a secure position for electro medical devices. Rounded edges avoid injuries.

The surfaces are easy to clean and resistant against disinfectants and detergents.

The push-and lift handle facilitates moving and lifting the carriage.

Large twin caster wheels Ø 100mm provide comfortable motion.

Front wheels lockable

Three shelves

[with optional equipment]

Item No.	Type	Scope of delivery / Description
4000-469	DT100 BI	10x vacuum electrode 1m; 1x support arm B; 1x vacuum unit DT100; 1x control unit with holder; 1x carriage I; 1x power cable; 250ml electrode spray
4000-471	DT100 BI	6x vacuum electrode 1m and 4x1,3m; 1x support arm B; 1x vacuum unit DT100; 1x control unit with holder; 1x carriage I; 1x power cable; 250ml electrode spray

Systems with accumulator battery:

4000-470	DT100A BI	10x vacuum electrode 1m; 1x support arm B; 1x vacuum unit DT100 with integrated accumulator battery ; 1x control unit with holder; 1x carriage I; 1x power cable; 250ml electrode spray
4000-472	DT100A BI	6x vacuum electrode 1m and 4x1,3m; 1x support arm B; 1x vacuum unit DT100 with integrated accumulator battery ; 1x control unit with holder; 1x carriage I; 1x power cable; 250ml electrode spray

DT100 B with carriage H



[similar to figure, with optional equipment]

DT100 BH with carriage

ECG vacuum unit with carriage H

This combination is also suitable for use in hospitals.

Easily manoeuvrable and solid carriage for ECG device and vacuum unit.

Front wheels lockable

4-fold socket board with circuit breaker.

Item No.	Type	Scope of delivery / Description
4000-483	DT100 BH	10x vacuum electrode 1m; 1x support arm B; 1x vacuum unit DT100; 1x control unit with holder; 1x carriage H; 1x power cable; 250ml electrode spray
4000-485	DT100 BH	6x vacuum electrode 1m and 4x1,3m ; 1x support arm B; 1x vacuum unit DT100; 1x control unit with holder; 1x carriage H; 1x power cable; 250ml electrode spray

Systems with accumulator battery:

4000-484	DT100A BH	10x vacuum electrode 1m; 1x support arm B; 1x vacuum unit DT100 with integrated accumulator battery ; 1x control unit with holder; 1x carriage H; 1x power cable; 250ml electrode spray
4000-486	DT100A BH	6x vacuum electrode 1m and 4x1,3m ; 1x support arm B; 1x vacuum unit DT100 with integrated accumulator battery ; 1x control unit with holder; 1x carriage H; 1x power cable; 250ml electrode spray

Subject to alterations. Our sales and delivery conditions are valid.

This product line catalogue is valid from 2025, January 01 and replaces all previous product line catalogues.

Strässle & Co. Medizintechnik GmbH Tel.: + 49 (0) 7432 22 01 86 Fax: + 49 (0) 7432 22 01 89 email: info@straessle-co.de

www.straessle-co.de

©Strässle & Co

EASY II

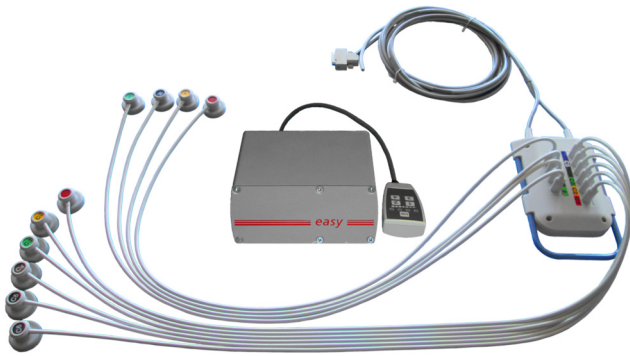

EASY II

A small, portable version of a suction system, without support arm

Designed for occasional applications, consisting of a distribution head with integrated defibrillation protection, electrode suction lines, patient line cable and vacuum unit with integrated one-hand operating module.

The system has proven control technology in four pressure stages and, like all Strässle vacuum systems, has an automatic blow-out before and after each application.

Specifications:

- Protection class I; MPG Class 1
- Supply voltage 230 V~ 50/60 Hz; 22 VA
- Vacuum range 60-200 mbar; 4-level vacuum capacity adjustment; pressure range and status indication
- Patient cable with integrated defibrillation protection;
- Silver-silver chloride electrodes; sucker material silicone; individually exchangeable from the outside

Item No.	Type	Scope of delivery / Description
4000-405	EASY II	10x vacuum electrode 1m; 1x vacuum unit EASY with control unit and holder for control unit; 1x patient cable with distributor; 1x power cable; 250ml electrode spray
4000-406	EASY II	6x vacuum electrode 1m and 4x1.3m; 1x vacuum unit EASY with control unit and holder for control unit; 1x patient cable with distributor; 1x power cable; 250ml electrode spray
4000-407	EASY II	10x vacuum electrode 1.3m; 1x vacuum unit EASY with control unit and holder for control unit; 1x patient cable with distributor; 1x power cable; 250ml electrode spray

DT Basic and DT Basic T

Application with self-adhesive electrodes

DT Basic

Our basic product for specific use with self-adhesive electrodes.
The compact version for practical use, especially in confined space situations.

The hinge moving vertically within a radius of 150 degrees, and with a cushioned horizontal pivoting radius of 360 degrees.

Including table clamp



[Illustration with special equipment, table is not included]

Item No.	Type	Scope of delivery / Description
4000-091	DT Basic	1x support arm Basic; 1x patient line cable with distributor Basic; 1x electrode lead set DT Basic 6/4; 1x clamping device

DT Basic T

Our basic product for specific use with self-adhesive electrodes.
Its functionality and design reflect the current demands on an intelligent support arm.

The innovative design and material results in an efficient and space-saving support arm system.

The telescopic arm is stepless extendable from 84cm to 132cm.

The hinge moving vertically within a radius of 150 degrees, and with a cushioned horizontal pivoting radius of 360 degrees.

Including table clamp



[Illustration with special equipment, table is not included]

Item No.	Type	Scope of delivery / Description
4000-090	DT Basic T	1x support arm Basic T; 1x patient line cable with distributor Basic T; 1x electrode lead set DT Basic 6/4; 1x clamping device

Subject to alterations. Our sales and delivery conditions are valid.

This product line catalogue is valid from 2025, January 01 and replaces all previous product line catalogues.

Strässle & Co. Medizintechnik GmbH Tel.: + 49 (0) 7432 22 01 86 Fax: + 49 (0) 7432 22 01 89 email: info@straessle-co.de

www.straessle-co.de

©Strässle & Co

Vacuum units

Vacuum unit DT100

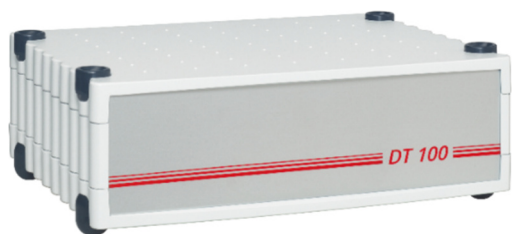

Large vacuum unit, with large-volume vacuum pump, designed for the highest demands in cardiology and clinics. Available as a mains-powered version for stationary use and as a battery-operated version for mobile use in daily clinical routine.

A special microprocessor control coordinates regulation and control of the overall function.

Dimensions B x L x H 330 x 268 x 120 mm²

Item No.	Type	Scope of delivery / Description
3000-201	DT100	1x vacuum unit DT100 without Accu
3000-202	DT100A	1x vacuum unit DT100 with Accu

Vacuum unit DT80 or EASY (with integrated remote control)



Small vacuum unit, designed for occasional use in the doctor's office.

A special microprocessor control coordinates regulation and control of the overall function.

Dimensions B x L x H 162 x 190 x 75 mm²

Item No.	Type	Scope of delivery / Description
3000-205	DT 80	1x vacuum unit DT80
3000-206	Easy	1x vacuum unit Easy



Remote control for DT100

Pluggable
For vacuum units DT100 und DT100A

Item No.	Type	Scope of delivery / Description
3000-156	Remote control	1x remote control for DT100 / DT100A

Support arms



[[Illustration with special equipment, electrode cables are not included]]

Example for use

Support arm T (telescopic)

Extendable in two steps from 84 cm to 132 cm.

The (locking) joint allows a vertical adjustment radius of 150 degrees.

Integrated rotation damping for horizontal swiveling through 360 degrees.

Item No.	Type	Scope of delivery / Description
3000-178	Support arm T	Support arm T without distributor (arm rack only)
3000-177	Distributor T	Distributor (pluggable) with patient line cable and vacuum hose, without electrode cables
4000-070	Support arm T	Support arm T complete (arm rack with distributor), without electrode cables

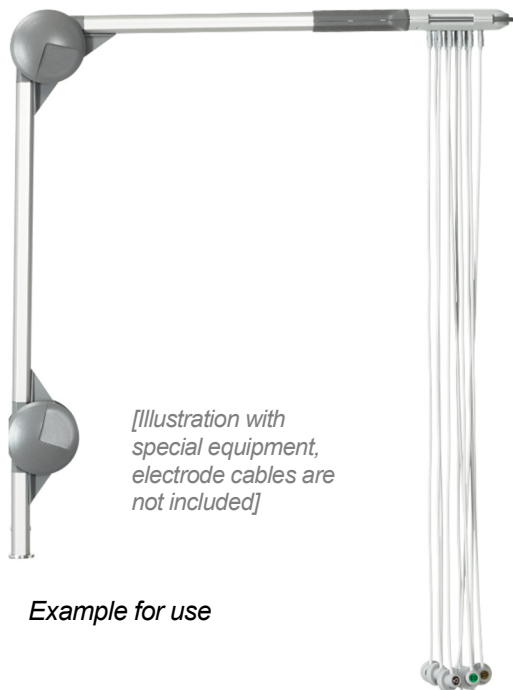

[[Illustration with special equipment, electrode cables are not included]]

Example for use

Support arm B

Variable positioning due to special design of the joints.

Automatic holding of the desired arm position, without additional manual fixation or locking.

Integrated rotation damping and over-rotation protection for horizontal swiveling up to 315° and large reach up to approx. 130 cm in stretched condition.

Item No.	Type	Scope of delivery / Description
3000-191	Support arm B	Support arm B, without electrode cables

carriage I

- Figure see reverse -



[shown carriage with optional equipment]

Carriage Basic equipment:

- **3 shelves**
- four twin caster wheels Ø 10cm, two of them lockable
- ! without mounting kit for support arm (additional equipment)!

Carriage Special equipment:

- Drawer
- Socket board fixing with reeling device
- Socket board

Specifications:

Height top plate:	82 cm
Height base plate:	14,5 cm
Plate size:	
Length x Width	49 x 50 cm
Weight:	
max. load	150 kg
max. load per shelf	50 kg

Item No.	Scope of delivery / Description
4000-180	Carriage I Rack with 4 twin caster wheels Ø 100mm, 2 of them lockable, 3 shelves, sliding handle.

Extras

1000-257	Socket board 6-fold with circuit-breaker
1000-258	Fixing for socket board with reeling device
1000-259	Drawer
1000-260	Additional shelf

carriage H

Carriage H

Table height 91 cm
 Table area 47x34 cm
 Base plate and table plate in plastic material.
 Including bracket for support arm.

4 turnable twin caster wheels.
 Front wheels lockable.

Maximum load of each shelf 15 kg.

The carriage is equipped with a 4-fold socket board with circuit breaker.

- front view -



- rear view -



[similar to figure]

4 turnable twin caster wheels



Item No.	Scope of delivery / Description
4000-179	Carriage H Rack with 4 turnable twin caster wheels, 2 of them lockable, 2 shelves, sliding handle, power cable

Extras

1000-514	Drawer
1000-515	Additional shelf

Carriage Plus



[shown carriage with optional equipment]

Carriage Plus (mobile stand)

For mobile operation
 Base plate in very solid design

Total height about 80 cm
 Width 38 cm, Depth 40 cm

Four lockable caster wheels

For DT80 and DT100
 For support arm versions B, C and T

Item No.	Type	Scope of delivery / Description
3000-456	Carriage Plus DT100/DT80 B&T	1x Carriage Plus

Subject to alterations. Our sales and delivery conditions are valid.

This product line catalogue is valid from 2025, January 01 and replaces all previous product line catalogues.
 Strässle & Co. Medizintechnik GmbH Tel.: +49 (0) 7432 22 01 86 Fax: +49 (0) 7432 22 01 89 email: info@straessle-co.de
 www.straessle-co.de

©Strässle & Co

Mounting kits

Mounting kit 1 with mounting angle

Distance between corners 1	92 mm
Distance between corners 2	100 mm
Distance between corners 3	50 mm
Drilling hole diameter	5,5 mm

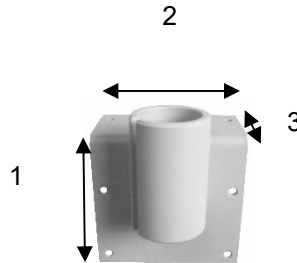

Item No.	Type	Scope of delivery/Description
3000-463	Mounting kit 1 DT100/DT80 B&T	1x fixing element; 2x allen screw

Mounting kit 2 with mounting angle

Distance between corners 1	92 mm
Distance between corners 2	100 mm
Distance between corners 3	50 mm
Drilling hole diameter	5,5 mm

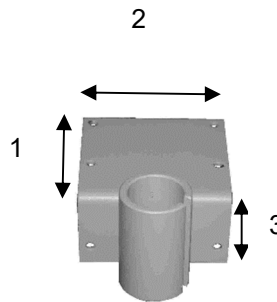

Item No.	Type	Scope of delivery/Description
3000-464	Mounting kit 2 DT100/DT80 B&T	1x fixing element; 2x allen screw

Mounting kit 3 with mounting angle

Distance between corners 1	50 mm
Distance between corners 2	92 mm
Distance between corners 3	100 mm
Drilling hole diameter	5,5 mm

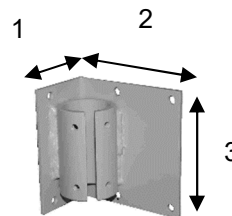

Item No.	Type	Scope of delivery/Description
3000-465	Mounting kit 3 DT100/DT80 B&T	1x fixing element; 2x allen screw

Mounting kit 4
fastening on Haeberle trolley SWINGO

Fixing element with square nut M6, 10x10x5
 For vertical T-groove profiles, vertical insertion

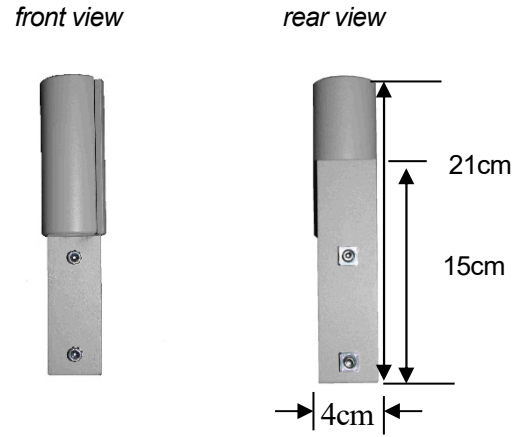

Item No.	Type	Scope of delivery/Description
3000-466	Mounting kit 4 DT100/DT80 B&T	1x fixing element; 2x allen screw; fixing material

Mounting kit 5
fastening on Munz trolley

Fixing element for vertical T-groove profiles
 Vertical insertion

Square nut M8, 13x13x 4



Item No.	Type	Scope of delivery/Description
3000-467	Mounting kit 5 DT100/DT80 B&T	1x fixing element; 2x allen screw; fixing material

Mounting kit 6

Solid lateral fixation on vertical square profiles
 right- or left-handed use
 flange 92mm x 57mm

Drilling holes for M6 countersunk screws

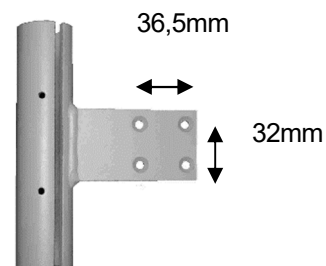

Item No.	Type	Scope of delivery/Description
3000-468	Mounting kit 6 DT100/DT80 B&T	1x fixing element; 2x allen screw

Mounting kit 7 fastening on horizontal square tube

Fixation on horizontal square bar
24mm x 24mm

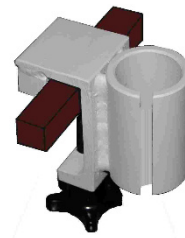

Example of use

Item No.	Type	Scope of delivery/Description
3000-469	Mounting kit 7 DT100/DT80 B&T	1x fixing element; 2x allen screw

Mounting kit 8 fastening on trolley Cardiomobil/Custo mobil/Cardio Cart/ErgoCart (ITD)

Fixation for 10mm profiled bars

Screw spacing 1 70mm
Screw spacing 2 64mm
Allen screw M6x12

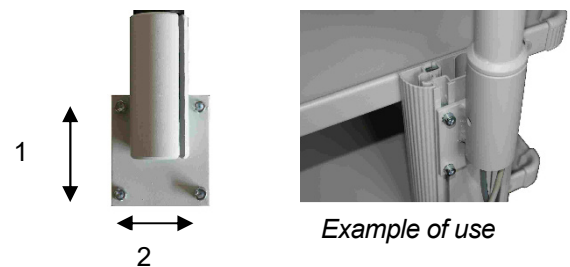

Example of use

Item No.	Type	Scope of delivery/Description
3000-460	Mounting kit 8 DT100/DT80 B&T for Cardiomobil/Custo mobil/ Cardio Cart/ErgoCart (ITD-classic cart)	1x fixing element; 2x allen screw; fixing material

Mounting kit 9 fastening on trolley Vacucar (Ohlenschläger)

Fixing element with counter plate and tap

Screw spacing 1 70mm
Screw spacing 2 64mm
Allen screw M6x12

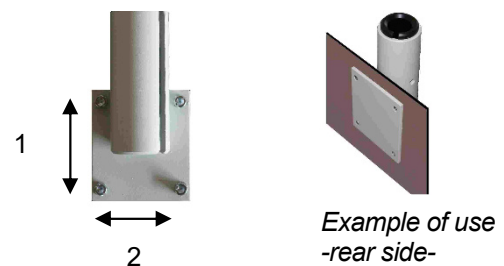

Example of use
-rear side-

Item No.	Type	Scope of delivery/Description
3000-461	Mounting kit 9 DT100/DT80 B&T for Vacucar	1x fixing element; 1 x counter plate; 2x allen screw

Mounting kit 10 fastening on DT100 on Schiller CS200 I

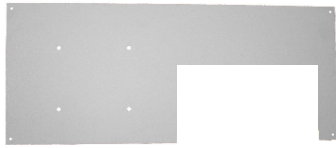

mounting sheet



pump holder set

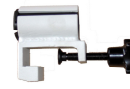

bracket

Item No.	Type	Scope of delivery/Description
3000-458	Mounting kit 10 DT100 B&T für Schiller CS200 I	1x fixing element; 2x allen screw; 1x mounting sheet; 1x pump holder set with fixing material

Mounting kit 11 fastening on Schiller CardioCart mobil

Holder with 3 threaded holes M6 on underside
each 120° offset



arm holder

D=68,5mm



armholder bottom side

Item No.	Type	Scope of delivery/Description
3000-453	Mounting kit 11 DT100/DT80 B&T for Schiller CardioCart mobil	1x arm holder 2x allen screw without fixing material

Mounting kit 12 fastening on Philips ST80i

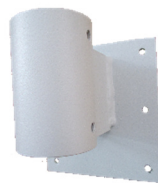

arm holder

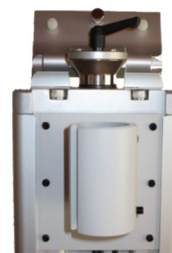

Example of use

Item No.	Type	Scope of delivery/Description
3000-059	Mounting kit ST80i DT100/DT80 T for Philips ST80i	1x arm holder 8x allen screw

Subject to alterations. Our sales and delivery conditions are valid.

This product line catalogue is valid from 2025, January 01 and replaces all previous product line catalogues.
Strässle & Co. Medizintechnik GmbH Tel.: + 49 (0) 7432 22 01 86 Fax: + 49 (0) 7432 22 01 89 email: info@straessle-co.de
www.straessle-co.de

©Strässle & Co

Mounting kit 13
fastening on Schiller CS200 II (Facelift)

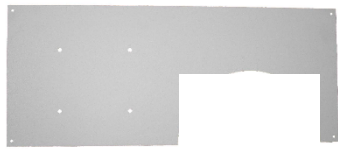

mounting sheet



pump holder set



mounting kit for support arm

Item No.	Type	Scope of delivery/Description
3000-472	Mounting kit DT100 B&T for CS200 II (Facelift)	1x mounting tube with fixing material; 1x allen screw; 1x mounting sheet; 1x pump holder set with fixing material

Mounting kit 14
fastening on rectangular tube



bracket

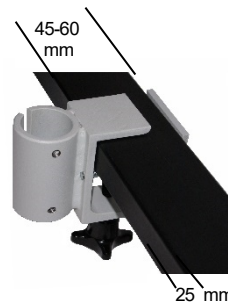

Example of use

Item No.	Type	Scope of delivery/Description
3000-158	Mounting kit 14 DT100/DT80 B&T for example for Schiller Ergo-Spiro	1x bracket; 1x angle; fixing material; 2x allen screw

Mounting kit 15
fastening on Philips TC cart

mounting sheet for pump unit and arm, pump holder, weight plates

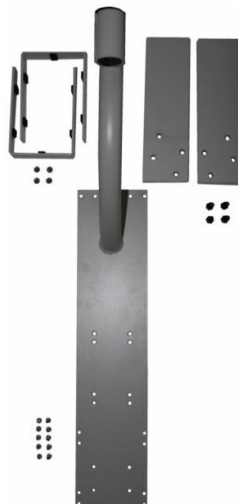

Example of use

Item No.	Type	Scope of delivery/Description
3000-473	Mounting kit 15 DT100 B&T for Philips TC cart	1x mounting sheet for pump unit and support arm; 2x allen screw; 1x pump holder set; 2x weight plates; fixing material

**Mounting kit 16
fastening on support rail**

for standard rail 25mm x 10mm



Item No.	Type	Scope of delivery/Description
3000-152	Mounting kit 16 DT100/DT80 B&T	1x fixing element; 2 x allen screw

**Mounting kit 17
clamp mounting for vertical rectangular profiles**

bracket 90° turned



Item No.	Type	Scope of delivery/Description
3000-153	Mounting kit 17 DT100/DT80 B&T	1x fixing element; 2 x allen screw

**Mounting kit 18
fastening on GE cart**



bracket

Pump holder

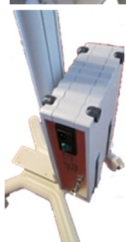

Examples of use

Item No.	Type	Scope of delivery/Description
3000-474	Mounting kit GE DT100 B&T for GE cart	1x fixing element 2x allen screw 1x base plate; 2x pump holder clamp 2x mounting bracket mounting material

Mounting kit 19
fastening on Schiller cart X1 and X3



bracket

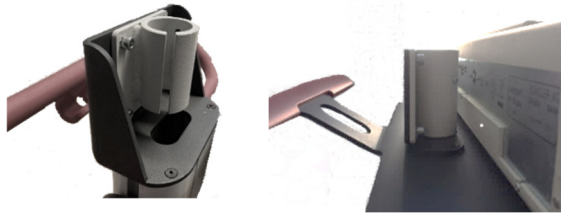

Examples of use

Item No.	Type	Scope of delivery/Description
3000-061	Mounting kit X1/X3 DT100/DT80 B&T for Schiller cart X1 and X3	1x fixing element 4x allen screw 4x toothed washer

Mounting kit 20
fastening on Schiller cart X2

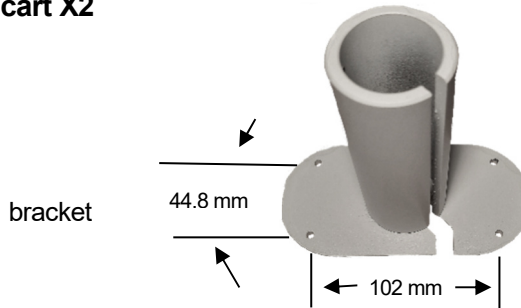

Example of use

Item No.	Type	Scope of delivery/Description
3000-062	Mounting kit X2 DT100/DT80 B&T for Schiller cart X2	1x fixing element 2x allen screw without mounting material

Mounting kit 21
fastening on Schiller cart X4 and X1 with FT-2



bracket



Example of use
pump mounting plate

Only item no. 3000-053



Example of use



Back side

Item No.	Type	Scope of delivery/Description
3000-065	Arm mounting X4 for support arm T for Schiller cart X4 and X1 with FT-2	1x arm holder; 1x adapter plate ; 4x securing bracket 2x countersunk screw ; 2x square nut 6x toothed washer; 8x inbus screw
3000-053	Mounting kit X4 DT80 T for Schiller cart X4 and X1 with FT-2	1x arm mount X4 kpl. (3000-065) Addition: 1x mounting plate; 4x inbus screw 4x toothed washer; 4x square nut

Mounting kit 22
fastening on GE cart MAC5 / MAC7

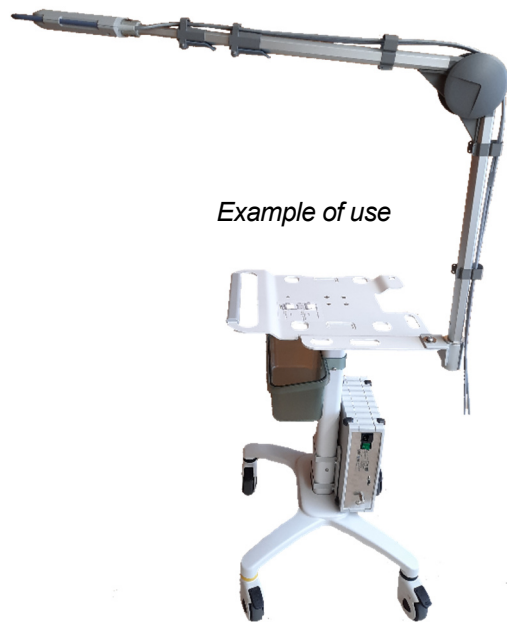
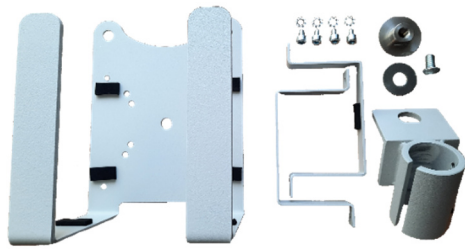

Item No.	Type	Scope of delivery/Description
3000-475	Mounting kit GE MAC5/MAC7 DT100 B&T for GE cart	1x arm holder with fitting nut 2x allen screw 1x pump holder for DT100 2x mounting bracket mounting material

Table clamp
clamp fastening e.g. on table tops or similar



Item No.	Type	Scope of delivery/Description
3000-457	Table clamp DT100/DT80 B&T	1x fixing element; 2 x allen screw

Accessory set for arm holders A
for support arm version A



Slide bush and parts for anti-twist protection

Suitable for all Strässle arm holders

Item No.	Type	Scope of delivery/Description
2000-123	Accessory set for arm holder A DT100/DT80	1x plastic sleeve 1x slot nut 1x dowel pin

Wall mount

Wall mount for support arm

(dimensions b x h 160 mm x 320 mm)

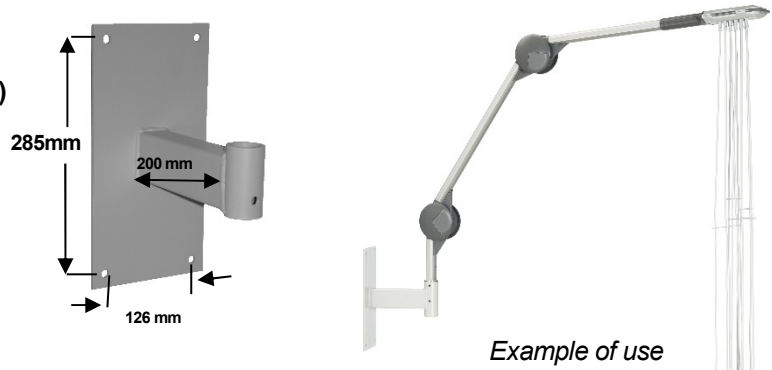

Item No.	Type	Scope of delivery/Description
3000-149	Wall mount for support arm DT100/DT80 B&T	1x wall mount 2x allen screw; fixing material

Wall mount for vacuum unit DT80 for vertical mounting



Item No.	Type	Scope of delivery/Description
3000-308	Wall mount for vacuum unit DT80	1x base plate 2x pump holder bracket DT80 2x stop angle DT80

Wall mount for vacuum unit DT100 for vertical mounting



Item No.	Type	Scope of delivery/Description
3000-309	Wall mount for vacuum unit DT100	1x base plate 2x pump holder bracket DT100

Accessories

Set of electrode distance holder



Example of use

Item No.	Type	Scope of delivery/Description
1000-160	Set of electrode distance holder	2x for 2 cable distance-holder; 2x for 3 cable distance-holder

Suction line holder for support arm A



Example of use

Item No.	Type	Scope of delivery/Description
3000-124	Suction line holder A DT100/DT80	1x suction line holder, self-adhesive



Item No.	Type	Scope of delivery/Description
3000-146	Fixing bracket for suction line holder A	1x fixing bracket with fixing material

Subject to alterations. Our sales and delivery conditions are valid.

This product line catalogue is valid from 2025, January 01 and replaces all previous product line catalogues.

Strässle & Co. Medizintechnik GmbH Tel.: + 49 (0) 7432 22 01 86 Fax: + 49 (0) 7432 22 01 89 email: info@straessle-co.de

www.straessle-co.de

©Strässle & Co

Suction line holder for support arm B



Example of use

Item No.	Type	Scope of delivery/Description
3000-104	Suction line holder B DT100 B/DT80 B	1x suction line holder; 1x fixing bracket with fixing material

Suction line holder for support arm C



Example of use

Item No.	Type	Scope of delivery/Description
3000-123	Suction line holder C DT100 C/DT80 C	1x suction line holder; 1x fixing bracket with fixing material

Suction line holder for support arm T

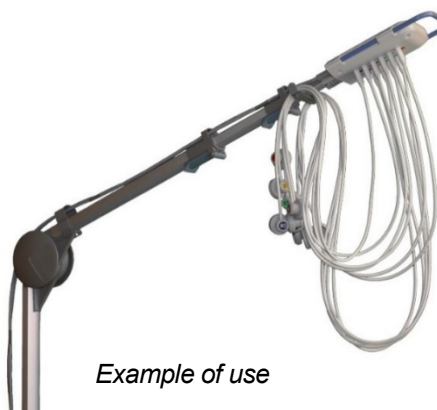

Example of use

Item No.	Type	Scope of delivery/Description
3000-105	Suction line holder T DT100 T/DT80 T	1x suction line holder; 1x fixing bracket with fixing material

Weight for patient line cable T



Example of use



Item No.	Type	Scope of delivery/Description
3000-106	Weight for patient line cable T DT100 T/DT80 T	1x weight; 5x O-ring

Brackets screwable for support arm T



For screwing the brackets to the support arm



Example of use

Item No.	Type	Scope of delivery/Description
3000-068	Brackets screwable for support arm T	1x bracket A screwable 1x bracket B screwable

Fixing bracket set for metal clip



For screwing on the clamps for cable fixing

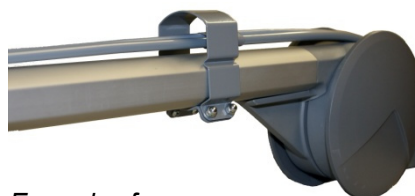

Example of use

Item No.	Type	Scope of delivery/Description
3000-069	Fixing bracket set for metal clip	1x fixing bracket with fixing material

Subject to alterations. Our sales and delivery conditions are valid.

This product line catalogue is valid from 2025, January 01 and replaces all previous product line catalogues.

Strässle & Co. Medizintechnik GmbH Tel.: + 49 (0) 7432 22 01 86 Fax: + 49 (0) 7432 22 01 89 email: info@straessle-co.de

www.straessle-co.de

©Strässle & Co

Bottle holder for contact spray for support arms T&B



Example of use

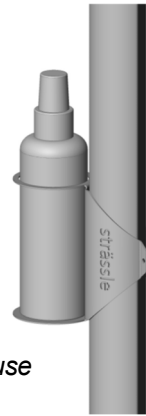

Item No.	Type	Scope of delivery/Description
3000-103	Bottle holder for contact spray for support arms B&T	1x Bottle holder for contact spray

Extension for patient cable 1.5m and 3m



Item No.	Type	Scope of delivery/Description
4000-025	Extension for patient cable 1.5m	1x cable
4000-068	Extension for patient cable 3m	1x cable

Adapter cable for WelchAllyn CardioPro and GE MAC2000



Item No.	Type	Scope of delivery/Description
4000-030	Adapter cable for WelchAllyn CardioPro	1x cable
4000-151	R-coupling/sub-D-connector	1x cable
4000-043	Adapter cable for GE MAC2000	1x cable

Medi-Box (connection adapter) for various ECG devices

With integrated original patient cables of the ECG manufacturers
(must be provided in advance when ordering)



Sample photo

Item No.	Type	Scope of delivery/Description
3000-127	Medi-Box for Philips Pagewriter	1x Adapter box
3000-116	Medi-Box for Philips ST80i	1x Adapter box
3000-122	Medi-Box for GE MAC 5000	1x Adapter box
3000-113	Medi-Box for GE CAM14	1x Adapter box
3000-112	Medi-Box for Mortara AM12 & WelchAllyn AM12CC	1x Adapter box
3000-117	Medi-Box for Nihon Kohden ECG 2450 or 2550	1x Adapter box

Test Box DT

Test aids for professional use in

- safety checks
- troubleshooting the entire system
- single electrode testing

With connection option for ECG simulators.

Particularly suitable for service technicians, both directly on site and for quick diagnosis in the workshop area.



Example of use

Item No.	Type	Scope of delivery/Description
5000-014	Prüfbox DT	1x Prüfbox DT

Subject to alterations. Our sales and delivery conditions are valid.

This product line catalogue is valid from 2025, January 01 and replaces all previous product line catalogues.
Strässle & Co. Medizintechnik GmbH Tel.: + 49 (0) 7432 22 01 86 Fax: + 49 (0) 7432 22 01 89 email: info@straessle-co.de
www.straessle-co.de

©Strässle & Co

Consumption and replacement material

For cleaning and disinfection of surfaces

Properties

- Ready-for-use alcoholic disinfectant for spraying or wiping
- Absolutely free aldehydes and alkylamines
- Extensive spectrum of activity: bactericide (incl. MSRA), tuberculocide and fungicide (incl. mould fungi)
- Effect in only 1min



1000-352



1000-354



1000-351



1000-327

Item No.	Type	Scope of delivery/Description
1000-352	Quick disinfectant	100 Cleansing tissues with dispenser
1000-354	Quick disinfectant	250ml sprayer
1000-351	Quick disinfectant	5l container
1000-327	Quick disinfectant	750ml foam sprayer

Electrode spray

High conductivity, for excellent signal quality and long life of electrodes



1000-158



1000-159

Item No.	Type	Scope of delivery/Description
1000-158	Electrode spray	250ml sprayer
1000-159	Electrode spray	3,8l container with spare sprayer

Suction lines with electrodes



Item No.	Type	Scope of delivery/Description
4000-002	Electrode 1m	1x silver-silver chloride electrode 1m
4000-004	Electrode 1,3m	1x silver-silver chloride electrode 1,3m

Suction line sets

4000-001	Electrode set 1m	10x silver-silver chloride electrode 1m with code plates
4000-003	Electrode set 1,3m	10x silver-silver chloride electrode 1,3m with code plates
4000-005	Electrode set 1m/1,3m	6x silver-silver chloride electrode 1m with code plates (C1-C6) 4x silver-silver chloride electrode 1,3m with code plates (R,L,F,N)

Code plates for electrodes

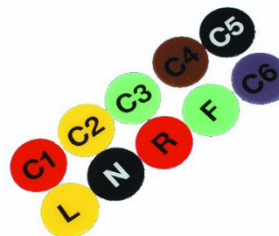

Item No.	Type	Scope of delivery/Description
2000-159	Code plate set	Ever 1x R,L,F,N,C1,C2,C3,C4,C5,C6

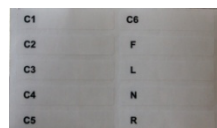
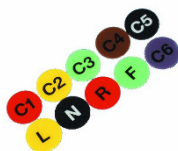

Example of use

Item No.	Type	Scope of delivery/Description
2000-646	Code plate set with code plates and identifier for electrodes	Ever 1x R,L,F,N,C1,C2,C3,C4,C5,C6

Subject to alterations. Our sales and delivery conditions are valid.

This product line catalogue is valid from 2025, January 01 and replaces all previous product line catalogues.

Strässle & Co. Medizintechnik GmbH Tel.: + 49 (0) 7432 22 01 86 Fax: + 49 (0) 7432 22 01 89 email: info@straessle-co.de

www.straessle-co.de

©Strässle & Co

leads for self-adhesive electrodes with snap fastener



Single lines

Item No.	Type	Scope of delivery/Description
4000-101	Electrode cable 1,2m C1	1x snap fastener-electrode cable 1,2m coded
4000-102	Electrode cable 1,2m C2	1x snap fastener-electrode cable 1,2m coded
4000-103	Electrode cable 1,2m C3	1x snap fastener-electrode cable 1,2m coded
4000-104	Electrode cable 1,2m C4	1x snap fastener-electrode cable 1,2m coded
4000-105	Electrode cable 1,2m C5	1x snap fastener-electrode cable 1,2m coded
4000-106	Electrode cable 1,2m C6	1x snap fastener-electrode cable 1,2m coded
4000-107	Electrode cable 1,4m F	1x snap fastener-electrode cable 1,4m coded
4000-108	Electrode cable 1,4m N	1x snap fastener-electrode cable 1,4m coded
4000-109	Electrode cable 1,4m L	1x snap fastener-electrode cable 1,4m coded
4000-110	Electrode cable 1,4m R	1x snap fastener-electrode cable 1,4m coded

Lead set for self-adhesive electrodes

4000-100	Electrode set 1,2m/1,4m	6x snap fastener-electrode cable 1,2m with coding (C1-C6) 4x snap fastener-electrode cable 1,4m with coding (R,L,F,N)
----------	-------------------------	--

I. Allgemeine Geschäfts- und Lieferbedingungen für alle Vertragspartner**1. Preise**

Die vereinbarten Preise sind Nettopreise ab Albstadt, exklusive der jeweils gültigen Mehrwertsteuer, derzeit 19 % und exklusive Transport. Der Abzug von Skonto ist ausgeschlossen. Es gilt der jeweils gültige Listenpreis.

2. Zahlungsbedingungen

Rechnungen sind, soweit keine anderen Abmachungen getroffen werden, innerhalb 10 Tagen ab Rechnungsdatum ohne jeden Abzug (Skonto) zahlbar.

3. Verzug

Bei Zahlungsverzug werden unbeschadet weitergehender Rechte Verzugszinsen in Höhe von 10 % jährlich berechnet, es sei denn, der Kunde weist einen geringeren Verzugschaden nach.

4. Rücktritt

Kommt der Käufer mit seiner Zahlungspflicht in Verzug, sind wir berechtigt, vom Kaufvertrag zurückzutreten oder Schadenersatz wegen Nichterfüllung zu verlangen sowie die Ware zurückzunehmen. Der Käufer ist zum Rücktritt vom Vertrag bei Nichteinhaltung einer verbindlich zugesagten Lieferfrist erst dann berechtigt, wenn er uns schriftlich eine Nachfrist von 2 Wochen mit Ablehnungsandrohung geschickt hat. Höhere Gewalt und sonstiges unverschuldetes Unvermögen berechtigen uns, außer zum Rücktritt vom Vertrag, zur Verlängerung der Lieferfrist um die Dauer der Störung. Überschreiten die sich daraus ergebenden Verzögerungen den Zeitraum von 6 Wochen, so ist auch der Käufer berechtigt, hinsichtlich des betroffenen Leistungsumfanges vom Vertrag zurückzutreten. Sonstige Ansprüche bestehen nicht.

5. Gewährleistung

Unsere Gewährleistungsverpflichtung beschränkt sich nach unserer Wahl auf Nachbesserung oder Ersatzlieferung. Im Rahmen der Gewährleistung ersetzte Teile gehen in unser Eigentum über. Bei Fehlschlägen der Nachbesserung oder Ersatzlieferung bleibt dem Käufer das Recht vorbehalten, Herabsetzung der Vergütung oder nach seiner Wahl Rückgängigmachung des Vertrages zu verlangen. Unsere Garantieleistungen setzen voraus, dass das System jederzeit vorschriftsmäßig (vgl. Bedienungsanleitung, auf dem Gerät angebrachte Hinweise, sonstige Begleitunterlagen) benutzt worden ist (Lagerung, Transport, Geräteanschluss). Auf Verschleißmittel, hierzu gehören insbesondere die Elektrodenleitungen mit Anbauteilen, besteht kein Garantieanspruch. Gewährleistungsansprüche für Sachmängel unserer Produkte verjähren innerhalb eines Jahres ab Übergabe; die Regelung gemäß Punkt I, 7 bleibt unberührt.

6. Haftung

Der Einsatz unserer Produkte und deren Verwendung zu einem bestimmten Zweck ist ausschließlich Sache des Käufers und erfolgt auf dessen eigene Verantwortung. In keinem Fall haften wir für Schäden, die sich direkt oder indirekt durch unsachgemäßen Gebrauch, Störungen oder Betriebsausfall ergeben. Ausgeschlossen ist insbesondere die Haftung für Folgeschäden, entgangenen Gewinn oder Ersatzansprüche Dritter, soweit dies nach den gesetzlichen Bestimmungen zulässig ist.

7. Schadensersatzansprüche

Schadensersatzansprüche des Kunden wegen Pflichtverletzung, unerlaubter Handlung oder aus sonstigen Gründen sind ausgeschlossen, soweit nicht Vorsatz, grobe Fahrlässigkeit, die Verletzung einer wesentlichen Vertragspflicht, die Übernahme eines Beschaffungsrisikos oder einer Garantie vorliegen oder wir nach den Bestimmungen des Produkthaftpflichtgesetzes zwingend haften. Unsere Haftung für Schäden aus der Verletzung des Lebens, des Körpers oder der Gesundheit richtet sich nach den gesetzlichen Bestimmungen. In allen Fällen ist unsere Ersatzpflicht beschränkt auf den typischerweise eintretenden vorhersehbaren Schaden.

8. Angebote

Nur bei Verträgen über Warenlieferungen mit Verbrauchern sind wir 4 Monate ab Vertragsschluss an die mit dem Kunden schriftlichen vereinbarten Preise gebunden. Ist vorgesehen, dass die Lieferungen 4 Monate nach Vertragsschluss noch nicht abgeschlossen sind, wird bei Änderung der damals maßgeblichen Verhältnisse die jeweils gültige Preisliste anwendbar, bei Preiserhöhungen nur dann, wenn sie im Verhältnis zu den Veränderungen angemessen sind.

9. Aufrechnung

Die Aufrechnung mit bestrittenen oder nicht rechtskräftig festgestellten Gegenforderungen ist ausgeschlossen.

10. Eigentumsvorbehalt

Bis zur Erfüllung aller Forderungen, die uns aus jedem Rechtsgrund gegen den Kunden jetzt oder künftig zustehen, behalten wir uns das Eigentum an allen gelieferten und eingebauten Teilen vor. Bei Zugriffen Dritter auf unter Eigentumsvorbehalt stehender Ware, insbesondere durch Pfändungen oder einen Gerichtsvollzieher, wird der Käufer auf unser Eigentum hinweisen und uns unverzüglich benachrichtigen, damit wir unsere Eigentumsrechte durchsetzen können. Soweit der Dritte nicht in der Lage ist, uns die in diesem Zusammenhang entstehenden gerichtlichen oder außergerichtlichen Kosten zu erstatten, haftet hierfür der Kunde.

II. Besondere zusätzliche Geschäftsbedingungen für Kaufleute im Rahmen ihres Handelsgewerbes, für juristische Personen des öffentlichen Rechts und öffentlich rechtliche Sondervermögen

1. Die Geschäftsbedingungen sind Bestandteil aller mit uns geschlossenen Verträge, auch in künftigen Geschäftsverbindungen. Abweichenden Bedingungen des Kunden/Lieferanten wird widersprochen.

2. Unsere Verkaufsangebote sind freibleibend. Zwischenverkauf bleibt vorbehalten.

3. Bestellungen von Kaufleuten sind für uns nur verbindlich, soweit wir sie bestätigen oder ihnen durch Übersendung der Ware nachkommen; mündliche Nebenabreden nur, wenn wir sie schriftlich bestätigen.

4. Abweichend von den Bedingungen für alle Käufer gelten die am Tag der vorgenommenen Lieferung bzw. Abnahme geltenden Preislisten.

5. Die Gefahr geht auf den Käufer über, sobald die Sendung an die den Transport ausführende Person übergeben worden ist oder zwecks Versendung das Lager des Verkäufers verlassen hat. Wird der Versand auf Wunsch des Käufers verzögert, geht die Gefahr mit der Meldung der Versandbereitschaft auf ihn über.

6. Eine Bezugnahme auf technische Normen stellt keine Zusicherung dar.

7. Altgeräte, zu deren Rücknahme wir gem. § 10 des Gesetzes über das Inverkehrbringen, die Rücknahme und die umweltverträgliche Entsorgung von Elektro- und Elektronikgeräten verpflichtet sind, sind vom Käufer kostenfrei an uns zurückzusenden.

8. Im Rahmen eines ordentlichen Geschäftsganges dürfen unter Eigentumsvorbehalt stehende Gegenstände verarbeitet oder mit anderen Sachen verbunden und vermischt werden. An den dadurch entstehenden neuen Sachen erwerben wir Miteigentum; der Anteil berechnet sich nach dem Lieferwert der von uns gelieferten Sache. Die in unserem Eigentum oder Miteigentum stehenden Sachen sind sicher und sachgemäß aufzubewahren und gegen Diebstahl, Feuer und sonstige Gefahren zu versichern. Über sie darf nur im Rahmen eines ordnungsgemäßen Geschäftsganges verfügt werden. Insbesondere dürfen sie nur dann veräußert werden, wenn, falls nicht bar bezahlt wird, das Eigentum auch den Abnehmern gegenüber vorbehalten wird und ihnen die in diesem Abschnitt enthaltenen Verpflichtungen schriftlich auferlegt werden.

Alle Forderungen und Ansprüche gegen Dritte, die sich auf die in unserem Eigentum stehenden Sachen beziehen, sind sicherungshalber an uns abgetreten. An uns abgetretene Geldforderungen dürfen vom Kunden im Rahmen des ordnungsgemäßen Geschäftsganges im eigenen Namen, jedoch für unsere Rechnung, eingezogen werden. In anderer Weise darf über diese Forderungen nicht verfügt werden. Insbesondere dürfen sie nicht noch einmal abgetreten werden, auch nicht zum Zwecke des Forderungseinzugs im Wege des Factoring, es sei denn, es wird gleichzeitig die Verpflichtung des Factors begründet, die Gegenleistung in Höhe unseres Forderungsanteils solange unmittelbar an uns zu bewirken, als noch Forderungen unsererseits gegen den Auftraggeber bestehen. Bei vertragswidrigem Verhalten des Kunden, insbesondere bei Zahlungsverzug, sind wir berechtigt, die Herausgabe der in unserem Eigentum stehenden Sachen oder Abtretung der Herausgabeansprüche des Kunden gegen Dritte zu verlangen. Dasselbe gilt, wenn uns eine wesentliche Verschlechterung der Vermögensverhältnisse des Kunden bekannt wird und dadurch unsere Ansprüche gefährdet werden. In diesen Fällen können wir die Ermächtigung zur Veräußerung der gelieferten Sachen und zur Einziehung der an uns abgetretenen Geldforderungen widerrufen und die Forderungen selbst einziehen. Die Geltendmachung unseres Herausgabeanspruchs gemäß vorstehenden Bestimmungen oder die Pfändung einer in unserem Eigentum stehenden Sache berührt die Durchführung des Vertrages nicht, insbesondere ist dies nicht als Rücktritt vom Vertrag anzusehen. Die für uns bestehenden Sicherheiten dienen der Sicherstellung aller Forderungen gegen den Kunden. Überschreitet ihr Wert unsere Forderung um mehr als 20 %, geben wir auf Verlangen einen entsprechenden Teil der Sicherheiten nach unserer Wahl frei. Zugriffe Dritter auf die uns gehörenden Waren und Forderungen sind uns vom Kunden unverzüglich mitzuteilen.

9. Für sämtliche Ansprüche aus der Geschäftsverbindung ist ausschließlicher Gerichtsstand der Sitz unseres Unternehmens.

10. Der Erfüllungsort ist der Sitz unseres Unternehmens. Dort sind auch sämtliche Fakturen zahl- und klagbar.

11. Es gilt ausschließlich deutsches Recht.

12. Bei Unwirksamkeit einzelner Vertragsklauseln wird die Wirksamkeit aller sonstigen Vereinbarungen nicht berührt. Anstelle der unwirksamen Klausel gilt eine dem Zweck wirtschaftlich möglichst nahestehende Regelung.

Subject to alterations. Our sales and delivery conditions are valid.

This product line catalogue is valid from 2025, January 01 and replaces all previous product line catalogues.

Strässle & Co. Medizintechnik GmbH Tel.: + 49 (0) 7432 22 01 86 Fax: + 49 (0) 7432 22 01 89 email: info@straessle-co.de

www.straessle-co.de

©Strässle & Co